

**DESIGN COPYRIGHT – 5/7/2025**  
ALL RIGHTS RESERVED AND MAY  
NOT BE DUPLICATED WITHOUT OUR  
WRITTEN PERMISSION

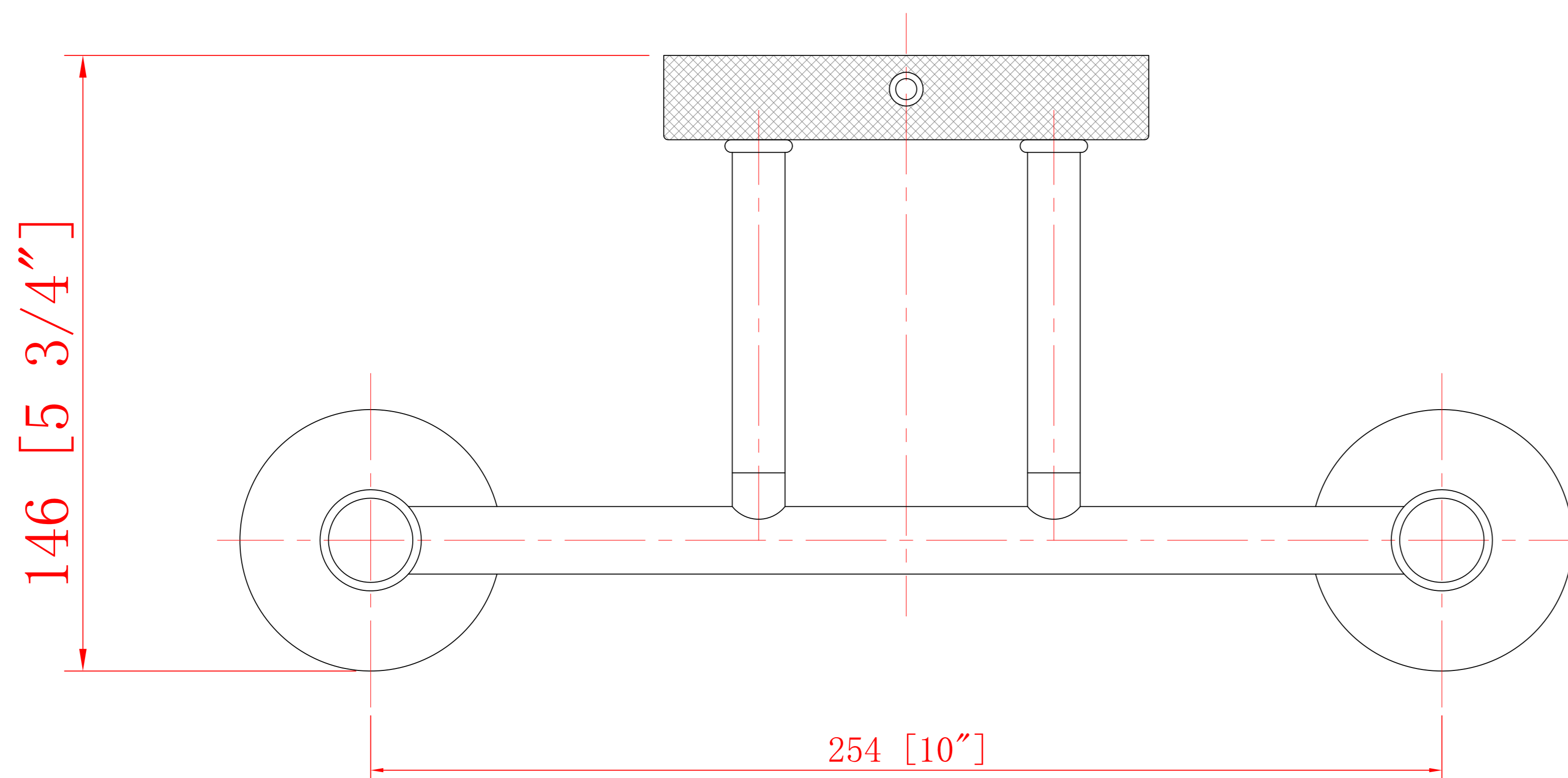
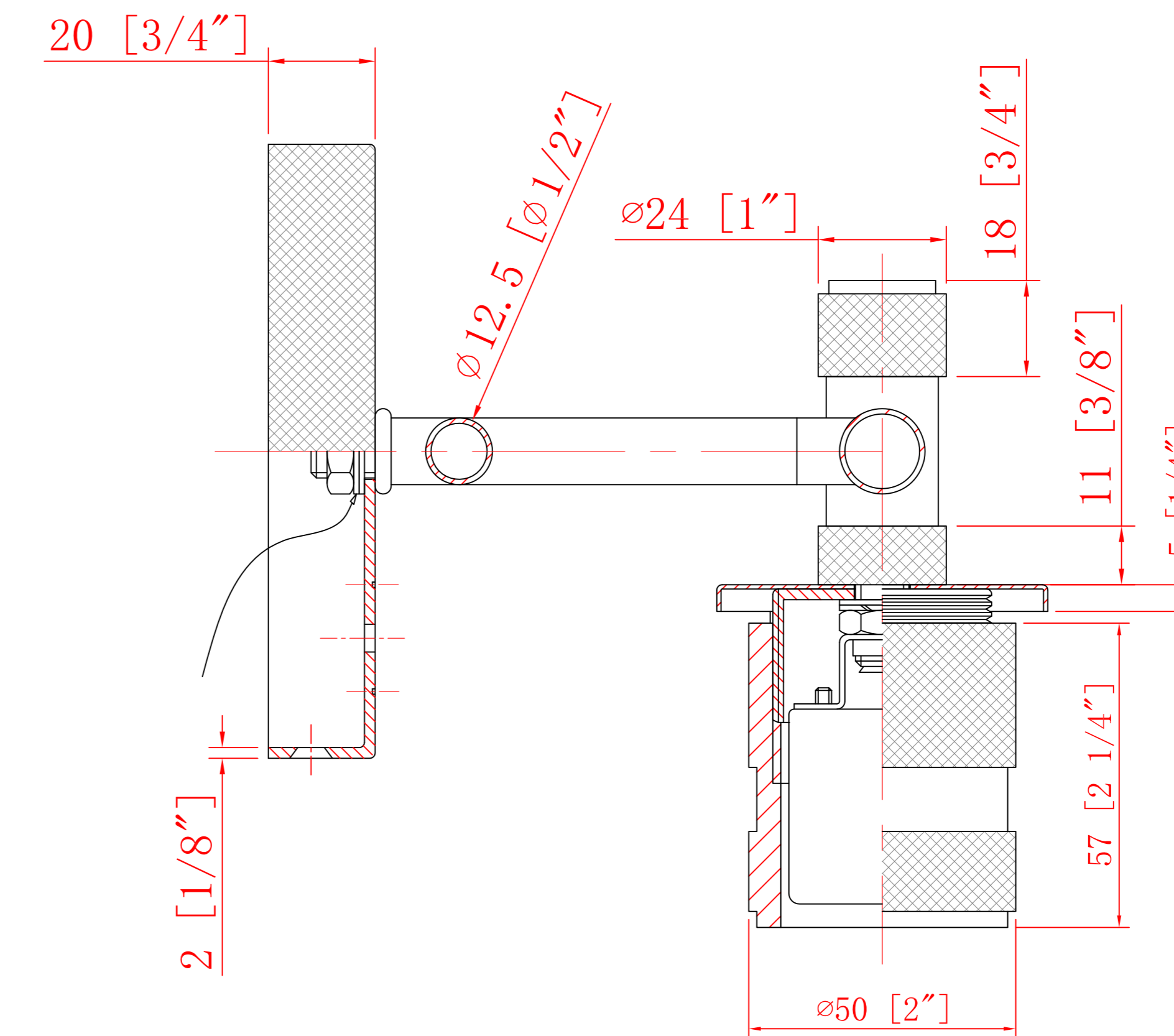
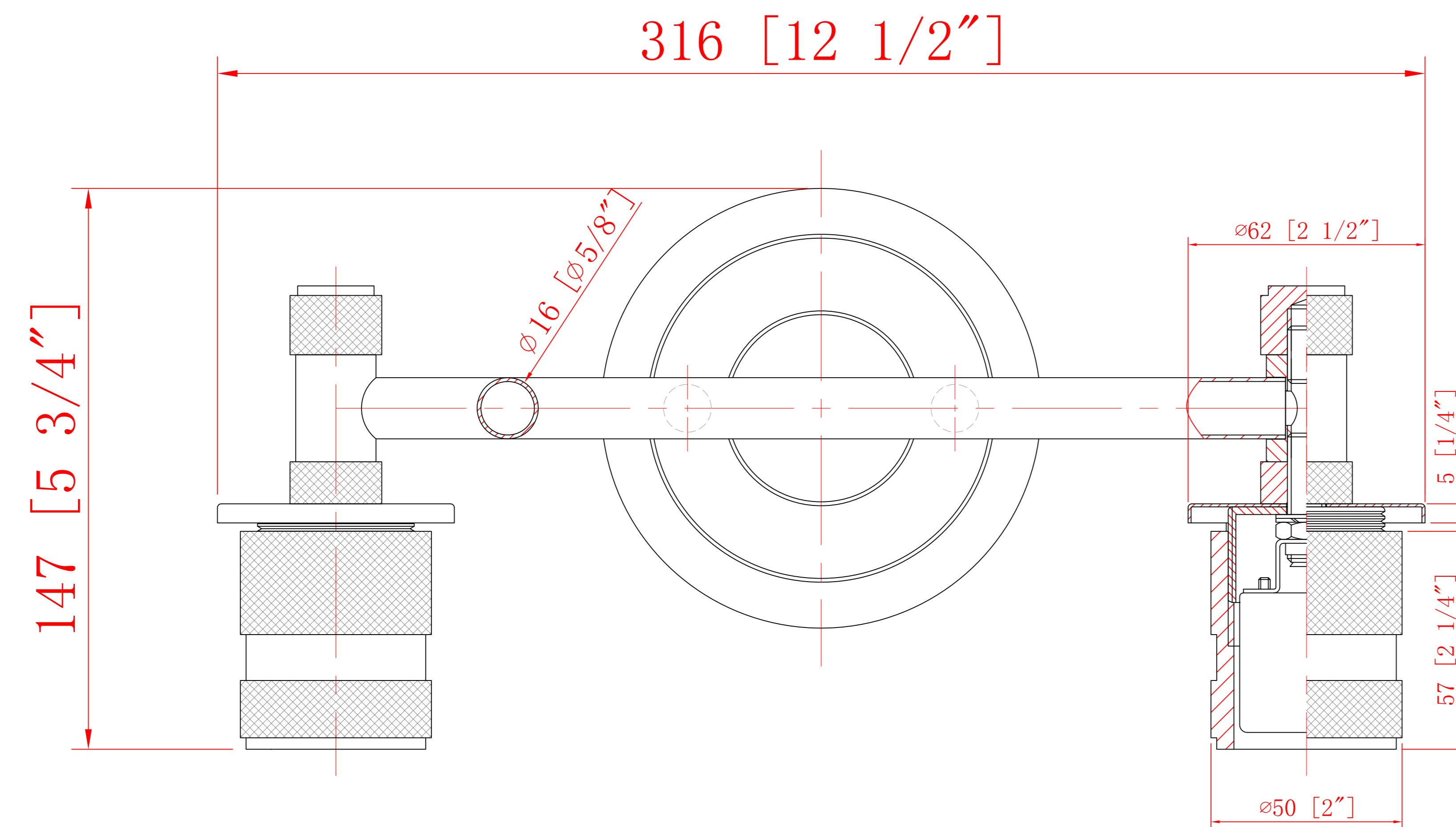

**ITEM: 434-2W**