

DESIGN COPYRIGHT – 05/20/2025

ALL RIGHTS RESERVED AND MAY
 NOT BE DUPLICATED WITHOUT OUR
 WRITTEN PERMISSION

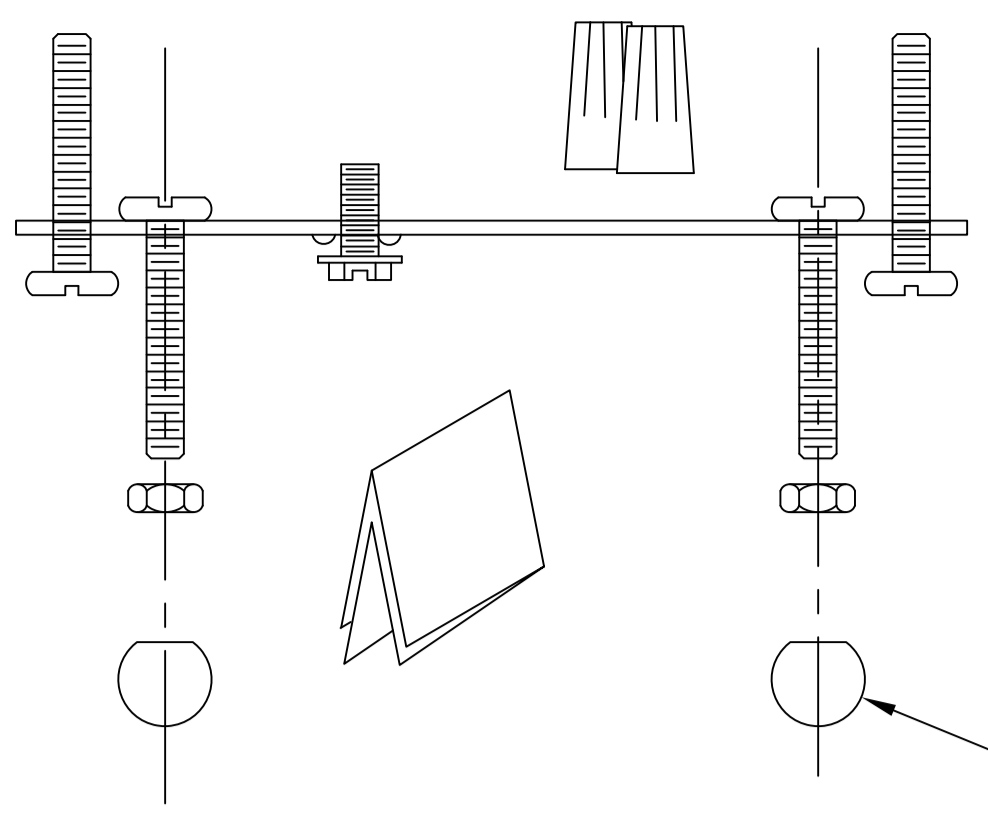

$\phi 10$ [$\phi 3/8$ "]

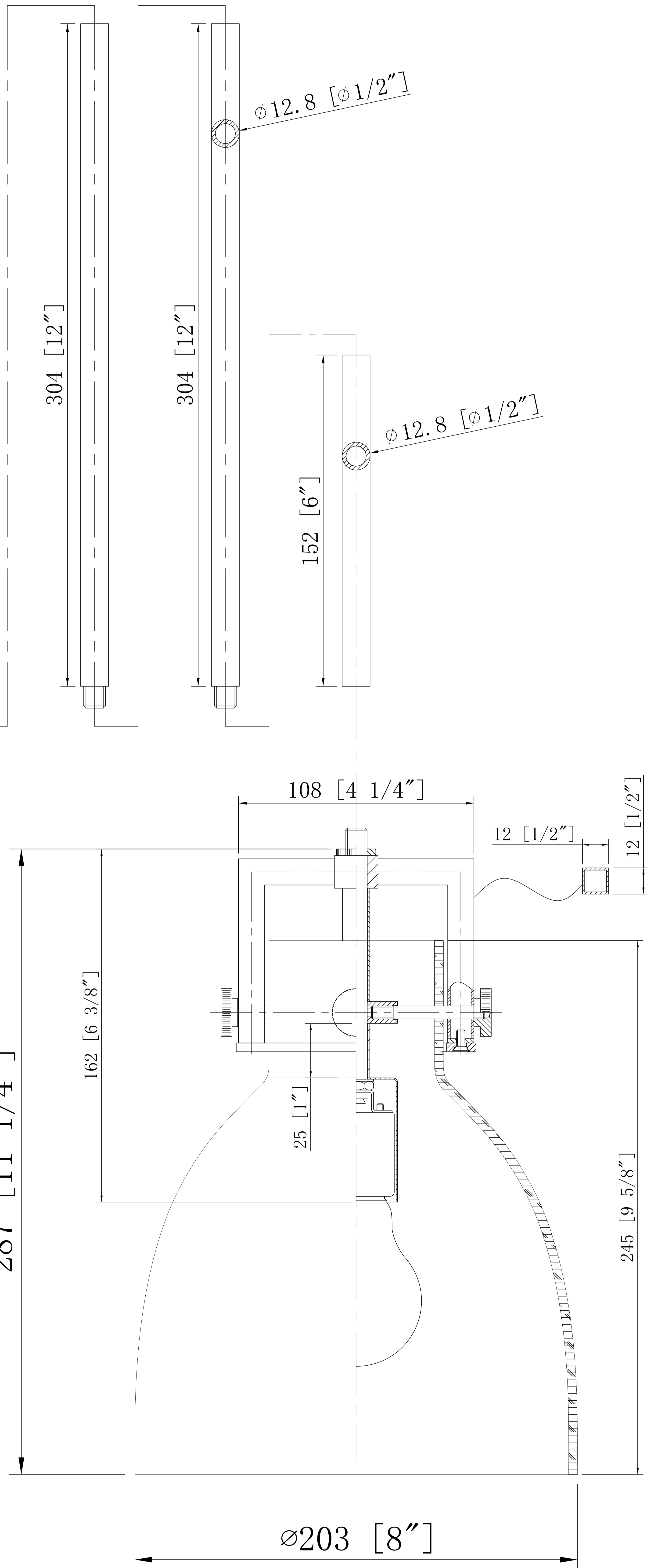
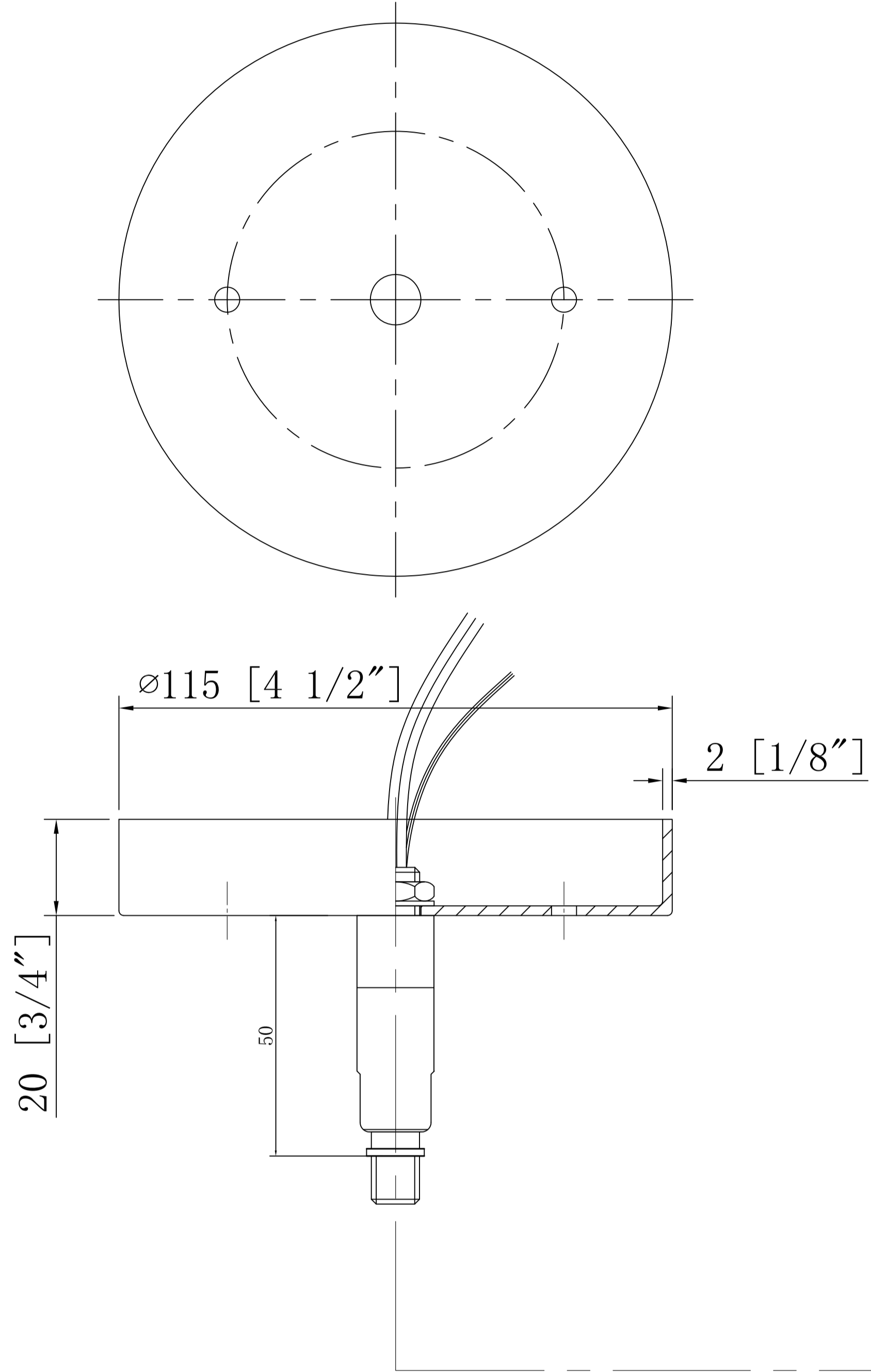

ITEM: 411-1SS-G412-8