







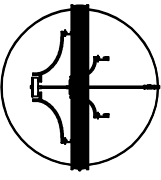

Assembly Instruction Sheet #IS-9957P42 For Style 9957P42

Tools Required: Flathead screwdriver, Phillips screwdriver, pliers, wire cutters, wire strippers, electrical tape, safety glasses.
Light Source: (12) Candleabra Base Bulbs 60W Maximum.
Preparation: Identify and inspect all parts before beginning installation. Check package content list and diagrams below to be sure all parts are present. If any parts are missing or damaged, do not attempt to assemble, install, or operate the fixture. Contact customer service for replacement parts.

Warnings and Cautions

Turn off electricity at circuit breaker or main fuse box before installation. Consult a licensed electrician if in doubt. These instructions are provided for your safety. It is very important you read them completely before installing the fixture. We strongly recommend that a licensed, professional electrician perform the installation. Disconnect fixture from power source before replacing bulbs. Make sure bulbs are given sufficient time to cool before removal.

Package Contents

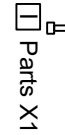
-  Fixture Body X1
-  Socket sleeve X12
-  Crystal ball X1
-  Ceiling Canopy X1
-  Parts X2
-  Middle Canopy X1
-  Parts X1
-  Bobèche X12
-  Parts X2

STEP 1 - Install Side Arms to Fixture Body

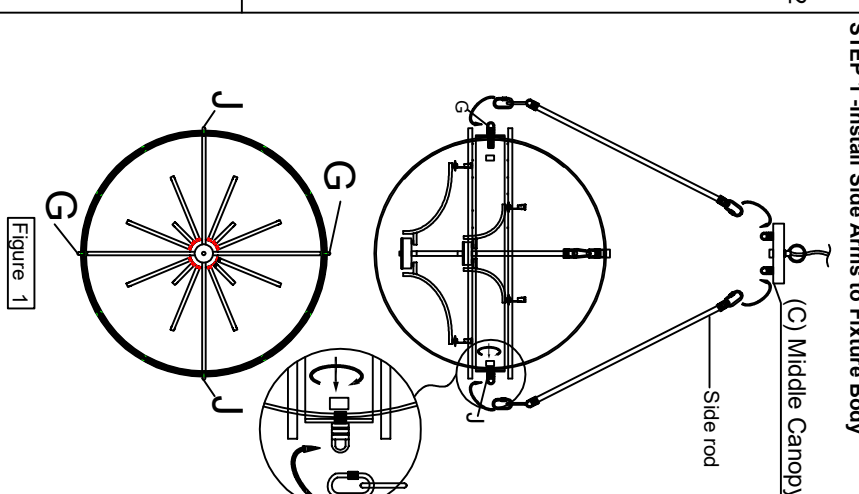

(C) Middle Canopy

Side rod

G

Figure 1

Hardware Contents

PART	DESCRIPTION	QUANTITY
BB	Wire nut	2pos
EE	Screw	2pos

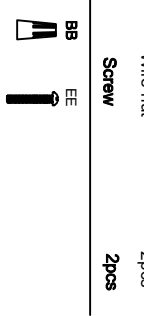

STEP 2 - Install the Canopy Chain Loop and Nipple

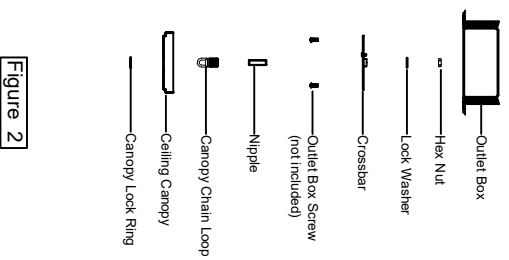

Figure 2

STEP 4 - Wire Connections

A. Use standard wire connectors (not included) to make all wire connections. Twist connectors until wires are tightly joined together. Wrap each connection with approved electrical tape and carefully stuff all the connected wires into the Outlet Box.

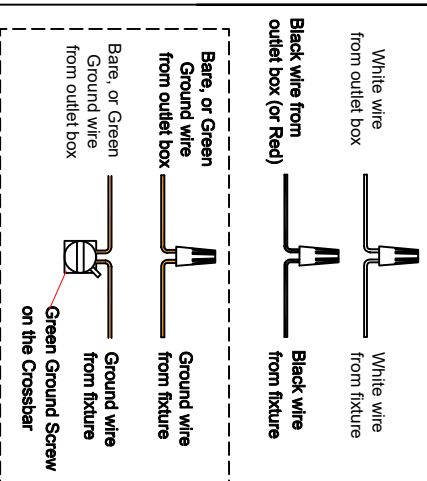

Figure 4

STEP 3 - Install the Fixture Chain and Ceiling Canopy

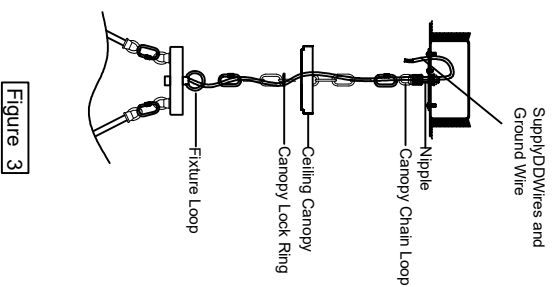

Figure 3

STEP 5 - Install Bobèches, Candle Covers, Crystal Ball and Bulbs.

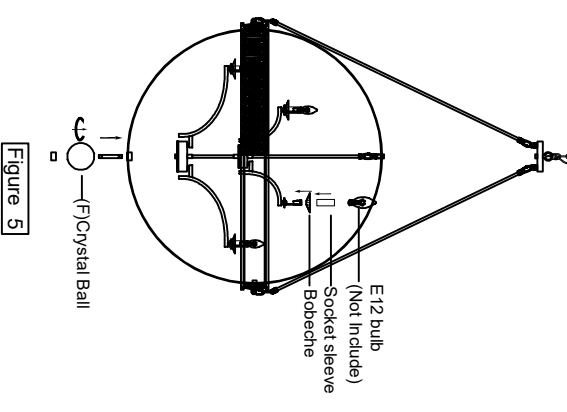

Figure 5

There are ways to adjust the Fixture body vertically

If you find the Bottom Crystal Ball can not line up the bottom frame finial . Please try belowing steps to adjust it.

First, if the direction of the lamp body and the crystal ball is not perfect, please gently rotate the Angle of the connecting rod to ensure that the crystal ball is at the center point.

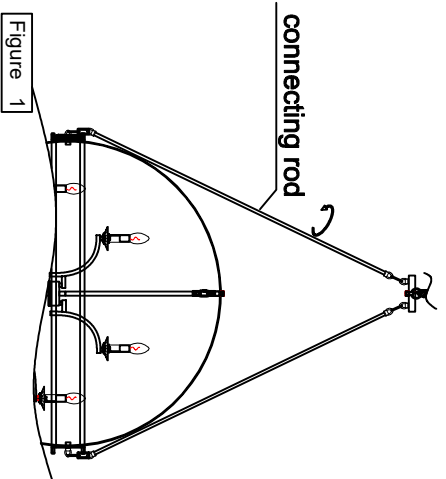

Figure 1

second , If the previous steps still not work, check which side is more heavy to make the crystal ball not in the center. Turn the loop on the side of the metal ring which will adjust the length of the side rods to make the weight of the fixture averagely then to keep the balance of the bottom ball.as shown in the figure

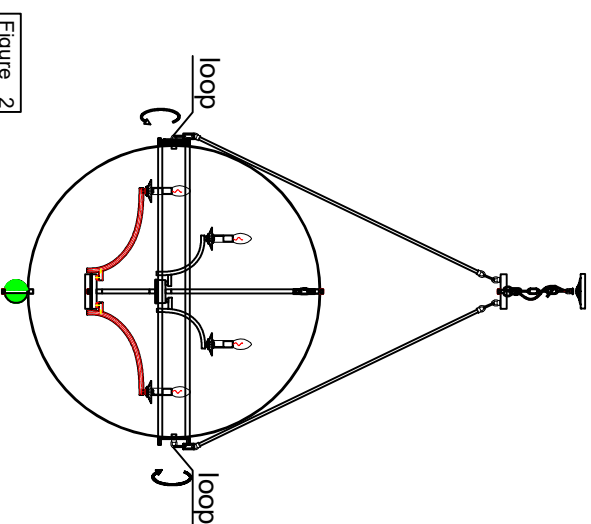

Figure 2

third , please check the arms are locked in averagely or not. If not , please adjust them , the space between them should be the same . This will make the fixture weight both sides the same.as shown in the figure

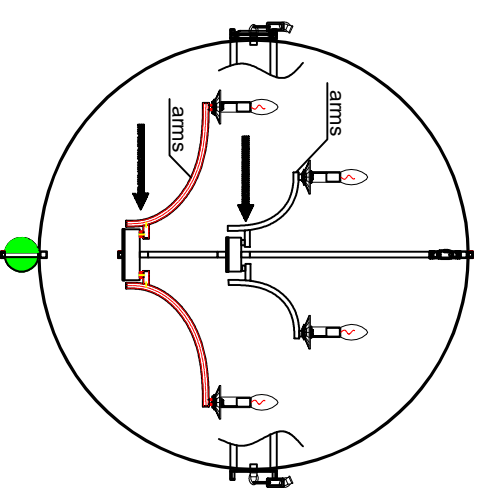

Figure 3

Fourth , If after the first step checking, the crystal ball still in the center. Exchange the bobèche both side. Different bobèche also have different thickness which effect the fixture weight bot side.as shown in the figure.

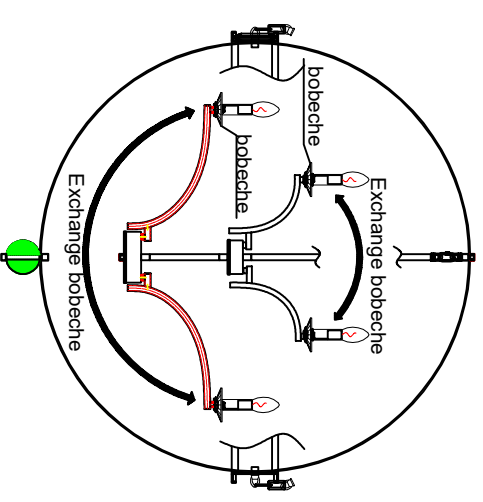

Figure 4