

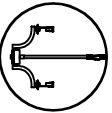









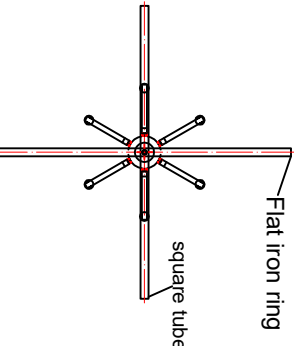
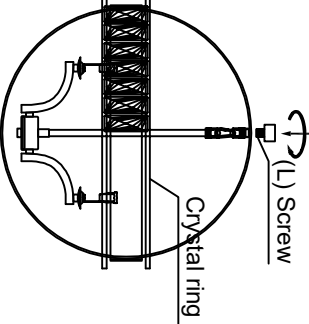

Assembly Instruction Sheet #IS-9957P30 For Style 9957P30C

Tools Required: Flathead screwdriver, Phillips screwdriver, pliers, wire cutters, wire strippers, electrical tape, safety glasses.
Light Source: (6) Candelabra Base Bulbs 60W Maximum.
Preparation: Identify and inspect all parts before beginning installation. Check package content list and diagrams below to be sure all parts are present. If any parts are missing or damaged, do not attempt to assemble, install, or operate the fixture. Contact customer service for replacement parts.

⚠ Warnings and Cautions

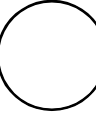
Turn off electricity at circuit breaker or main fuse box before installation. Consult a licensed electrician if in doubt. These instructions are provided for your safety. It is very important you read them completely before installing the fixture. We strongly recommend that a licensed, professional electrician perform the installation. Disconnect fixture from power source before replacing bulbs. Make sure bulbs are given sufficient time to cool before removal.

| | |
|--|---|
| <p>Package Contents</p> <ul style="list-style-type: none">  A Fixture Body X1  B Ceiling Canopy X1  C Plate X1  D Bobeche X6  E Socket sleeve X6  F Crystal ball X1  G Parts X2 | <p>STEP 1 -Install Flat iron ring to Fixture Body</p>  <p>STEP 2 -Install Crystal ring to Fixture Body.</p>  |
| <ul style="list-style-type: none">  H Parts X2  I Side rod X4  J Parts X1  K Chain X1  L Flat iron ring X1  M Screw X1  N Crystal ring X1 | |

STEP 3 - Install Parts.

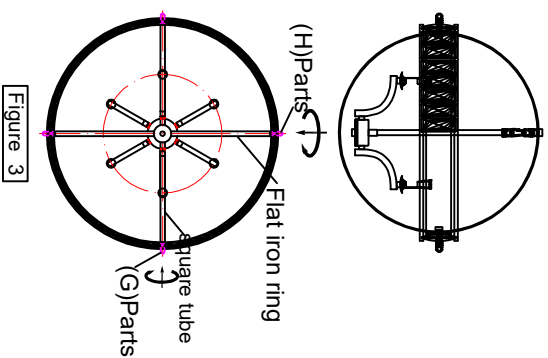

STEP 2 -Install Side rod to Fixture Body.

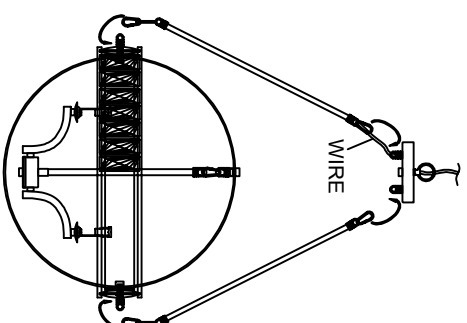

STEP 5 - Install Chain to Ceiling Canopy.

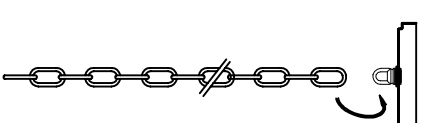

STEP 6 - Install Crystal Ball

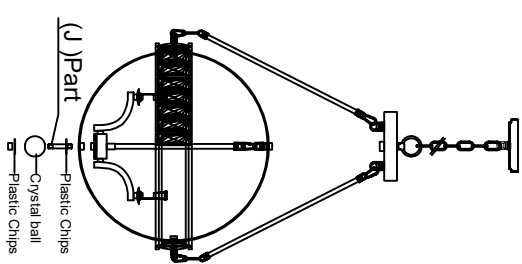

STEP 7 – Install the Canopy Chain Loop and Nipple

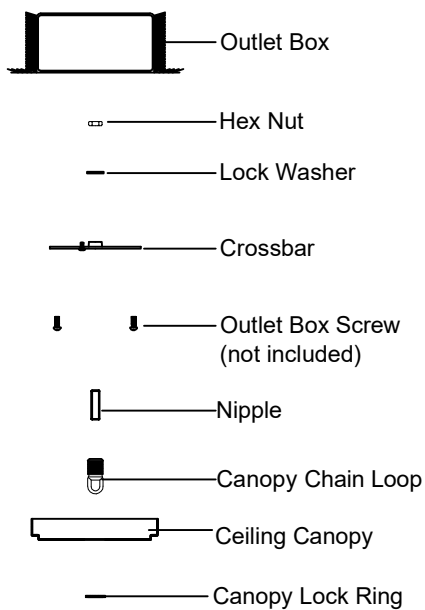

Figure 7

STEP 9 - Wire Connections

A. Use standard wire connectors (not included) to make all wire connections. Twist connectors until wires are tightly joined together. Wrap each connection with approved electrical tape and carefully stuff all the connected wires into the Outlet Box.

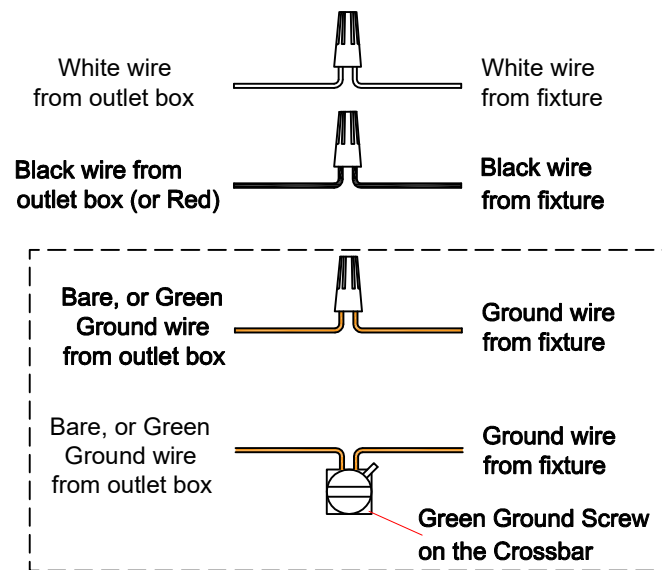

Figure 9

STEP 8 - Install the Fixture Chain and Ceiling Canopy

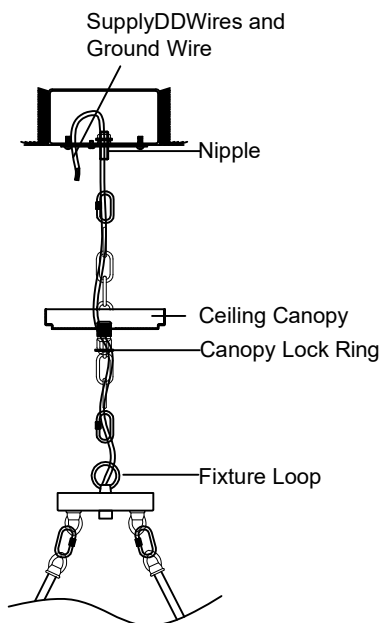

Figure 8

STEP 10 - Install Bobeches , Candle Covers and Bulbs.

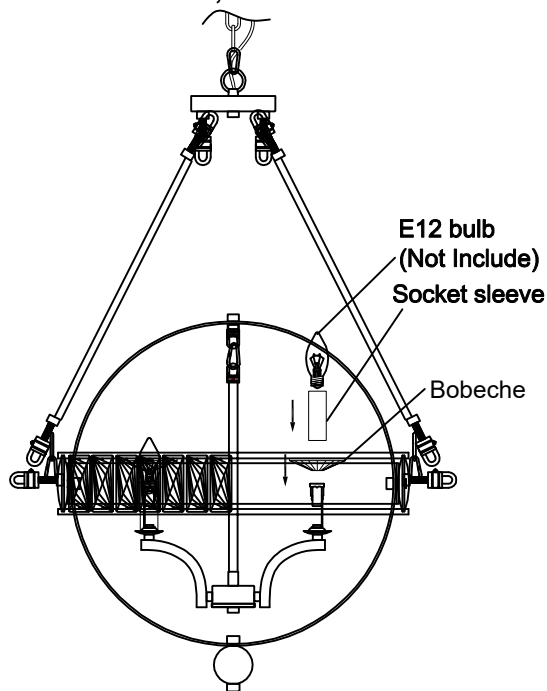

Figure 10