











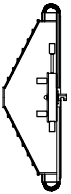

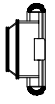
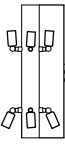
# Assembly Instruction Sheet #IS-8001P30G For Style 8001P30G

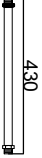
**Tools Required:** Flathead screwdriver, Phillips screwdriver, pliers, wire cutters, wire strippers, electrical tape, safety glasses.  
**Light Source:** (32) E12 Candelabra Base Bulbs 60W/Maximum(Not Include).  
**Preparation:** Identify and inspect all parts before beginning installation. Check package content list and diagrams below to be sure all parts are present. If any parts are missing or damaged, do not attempt to assemble, install, or operate the fixture. Contact customer service for replacement parts.

## Warnings and Cautions

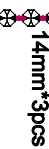
Turn off electricity at circuit breaker or main fuse box before installation. Consult a licensed electrician if in doubt. These instructions are provided for your safety. It is very important you read them completely before installing the fixture. We strongly recommend that a licensed, professional electrician perform the installation. Disconnect fixture from power source before replacing bulbs. Make sure bulbs are given sufficient time to cool before removal.

## Package Contents

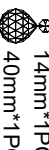
<b>A</b>  QTY X 1	<b>B</b>  QTY X 1	<b>C</b>  QTY X 1	<b>D</b>  400 QTY X 1	<b>E</b>  500 QTY X 1
<b>F</b>  520 QTY X 1	<b>G</b>  430 QTY X 1	<b>H</b>  50 QTY X 3	<b>I</b>  72 QTY X 2	<b>J</b>  QTY X 1
<b>1</b>  14mm*3pcs QTY X 271	<b>2</b>  40mm*1PCS QTY X 282	<b>3</b>  14mm*16pcs QTY X 28	<b>4</b>  14mm*20pcs QTY X 48	<b>5</b>  14mm*1PCS 40mm*1PCS QTY X 1

**STEP 1**

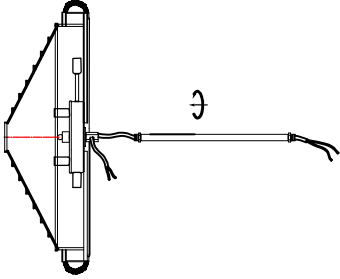

**PARTS**

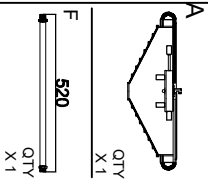

**NOTE**  
assemble parts as shown

**STEP 2**

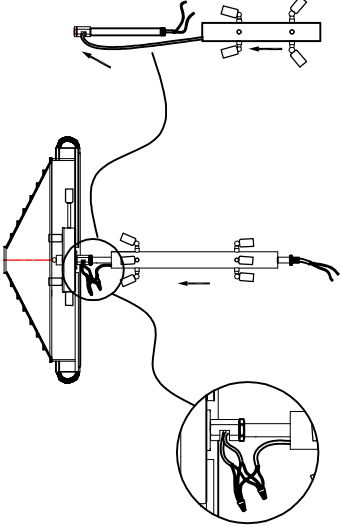

**PARTS**

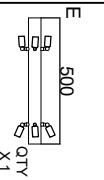

**NOTE**  
assemble parts as shown

**STEP 3**

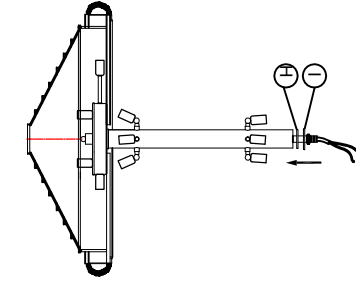

**PARTS**

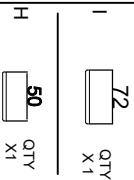

**NOTE**  
assemble parts as shown

**STEP 4**

**PARTS**

<b>B</b>		<b>QTY</b> X 1
----------	--	-------------------

**NOTE**  
assemble parts as shown

**STEP 5**

**PARTS**

<b>G</b>		430 <b>QTY</b> X 1
----------	--	--------------------------

**NOTE**  
assemble parts as shown

**STEP 6**

**PARTS**

<b>D</b>		<b>QTY</b> X 1
----------	--	-------------------

**NOTE**  
assemble parts as shown

**STEP 7**

**PARTS**

<b>I</b>		<b>QTY</b> X 1
<b>H</b>		50 <b>QTY</b> X 1

**NOTE**  
assemble parts as shown

**STEP 8**

**PARTS**

<b>C</b>		<b>QTY</b> X 1
----------	--	-------------------

**NOTE**  
assemble parts as shown

**STEP 9**

**PARTS**

**NOTE**  
assemble parts as shown

STEP 10

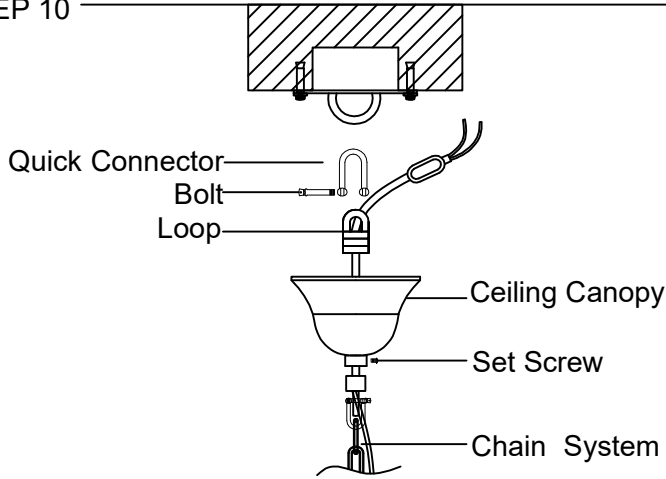





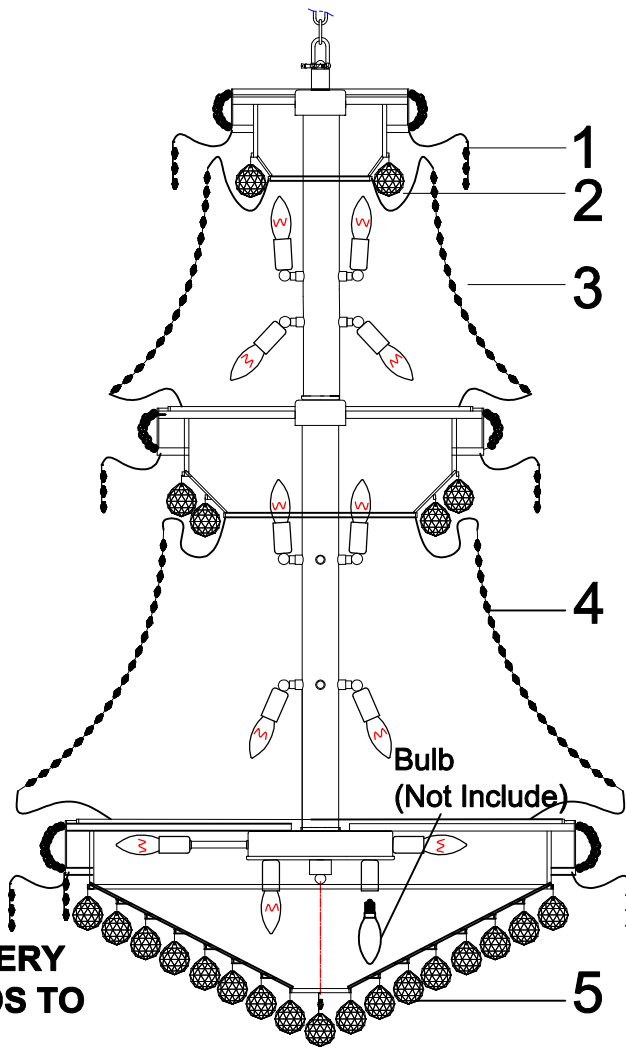

PARTS

NOTE  
assemble parts  
as shown



**WARNING**  
THIS FIXTURE IS VERY  
HEAVY AND NEEDS TO  
BE REINFORCDE  
ACCORDINGLY

1	 14mm*3pcs	QTY X 271
	Crystal	
2	 40mm*1PCS	QTY X 282
	Crystal	
3	 14mm*16pcs	QTY X 28
	Crystal	
4	 14mm*20pcs	QTY X 48
	Crystal	
5	 14mm*1PCS  40mm*1PCS	QTY X 1
	Crystal	