

# Assembly Instruction Sheet #IS-8001F-18G











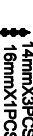

## For Style 8001F18G

**Tools Required:** Flathead screwdriver, Phillips screwdriver, pliers, wire cutters, wire strippers, electrical tape, safety glasses.  
**Light Source:** (9) E12 MAXYGOW (Bulbs Not Included)  
**Preparation:** Identify and inspect all parts before beginning installation. Check package content list and diagrams below to be sure all parts are present. If any parts are missing or damaged, do not attempt to assemble, install, or operate the fixture. Contact customer service for replacement parts.

### Warnings and Cautions

Turn off electricity at circuit breaker or main fuse box before installation. Consult a licensed electrician if in doubt. These instructions are provided for your safety. It is very important you read them completely before installing the fixture. We strongly recommend that a licensed, professional electrician perform the installation. Disconnect fixture from power source before replacing bulbs. Make sure bulbs are given sufficient time to cool before removal.

### Package Contents

- |   |                             |   |                         |
|---|-----------------------------|---|-------------------------|
|  | <b>E</b> Metal frame X 1    |  | 14mmX3PCS               |
|    | <b>A</b> Fixture Body x1    |  | 18mmX1PCS               |
|    | <b>B</b> Connecting pipe x1 |  | 20mmX1PCS               |
|    | <b>C</b> Part x1            |  | 22mmX1PCS               |
|    | <b>D</b> Gasket x1          |  | 24mmX1PCS               |
|   |                             |  | 14mmX3PCS               |
|   |                             |  | <b>2</b> Crystals 99PCS |
|   |                             |  | <b>3</b> Crystals 60PCS |

### Hardware Contents

PART	DESCRIPTION	QUANTITY
BB	Wire nut	2pcs
CC	Screw	2pcs



### STEP 1- Install Fixture Body.

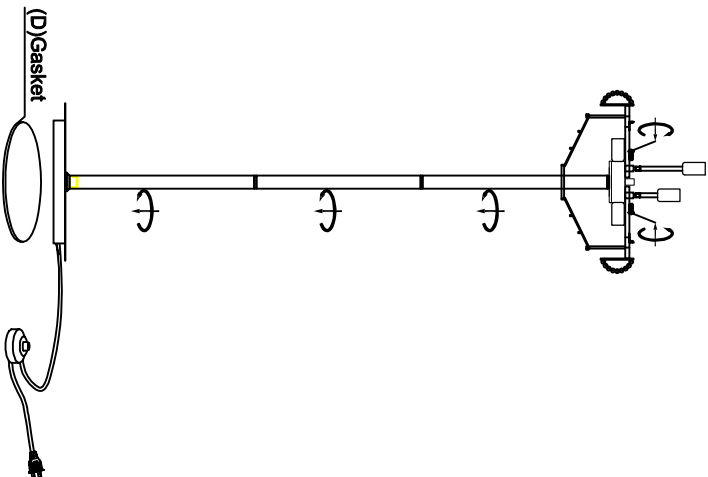

### STEP 2- Install Metal frame .

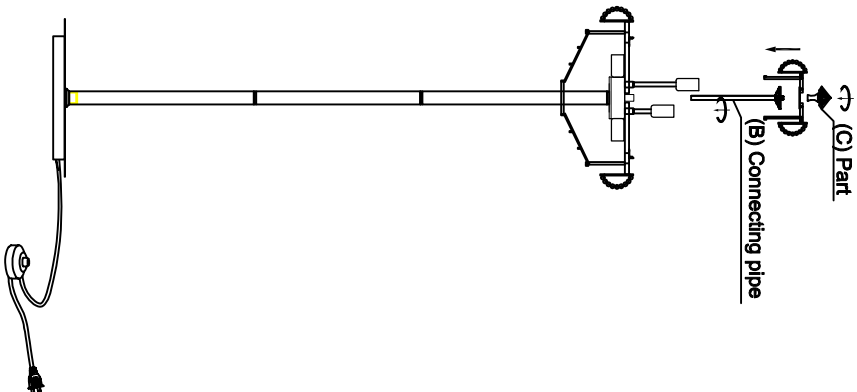

### STEP 3- Install Bulbs and Crystals .

