

Assembly Instruction Sheet #IS-5573P23-R For Style 5573P23-R

Tools Required: Flathead screwdriver, Phillips screwdriver, pliers, wire cutters, wire strippers, electrical tape, safety glasses.
Light Source: (15) G4 LED Bulb 2W Maximum (Not Include).
Preparation: Identify and inspect all parts before beginning installation. Check package content list and diagrams below to be sure all parts are present. If any parts are missing or damaged, do not attempt to assemble, install, or operate the fixture. Contact customer service for replacement parts.

Warnings and Cautions

Turn off electricity at circuit breaker or main fuse box before installation. Consult a licensed electrician if in doubt. These instructions are provided for your safety. It is very important you read them completely before installing the fixture. We strongly recommend that a licensed, professional electrician perform the installation. Disconnect fixture from power source before replacing bulbs. Make sure bulbs are given sufficient time to cool before removal.

Package Contents

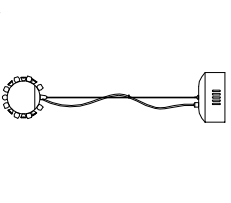
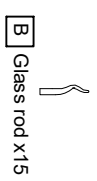
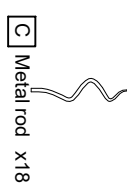
-  A | Fixture Body x1
-  B | Glass rod x15
-  C | Metal rod x18

Hardware Contents

PART	DESCRIPTION	QUANTITY
BB	Electrical Marrets	2pcs
CC	Outlet Box Screw	2pcs

STEP 1 - A. Release Crossbar from Ceiling Canopy

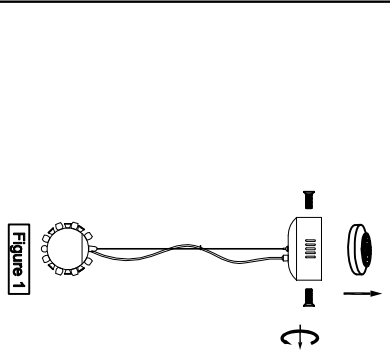

STEP 2 - Attach Mounting bracket to Outlet Box

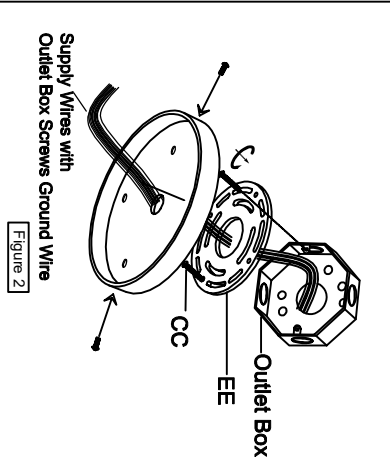

Supply Wires with Outlet Box Screws Ground Wire

STEP 3 - Wire Connections

A. Use standard wire connectors to make all wire connections. Twist connectors until wires are tightly joined together. Wrap each connection with approved electrical tape and carefully stuff all the connected wires into the Outlet Box.

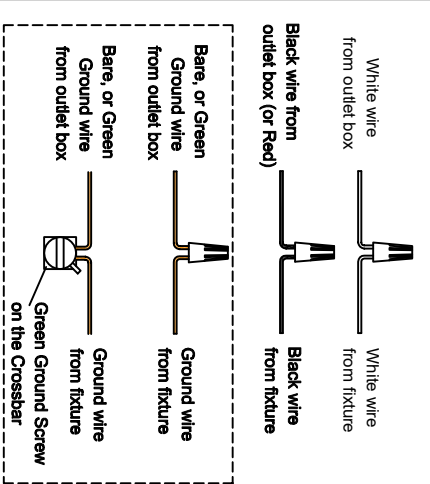

STEP 4 - Install Ceiling Canopy to Ceiling

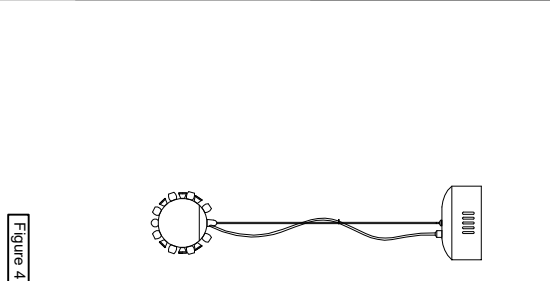

STEP 5 -Install Metal rod

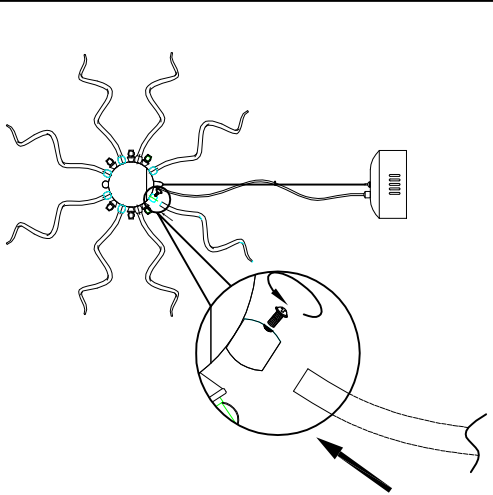

STEP 6 - Install Bulbs and Glass rod.

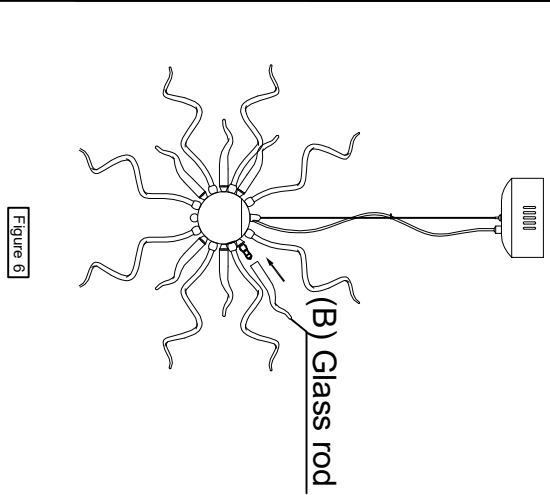

(B) Glass rod