







# Assembly Instruction Sheet #S-5006C14-R (W) For Style 5006C14-R (W)

**Tools Required:** Flathead screwdriver, Phillips screwdriver, pliers, wire cutters, wire strippers, electrical tape, safety glasses.  
**Light Source:** (6) G9 Bulb 40W Maximum (Not Include).  
**Preparation:** Identify and inspect all parts before beginning installation. Check package content list and diagrams below to be sure all parts are present. If any parts are missing or damaged, do not attempt to assemble, install, or operate the fixture. Contact customer service for replacement parts.

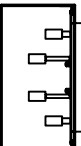
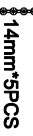
## ⚠ Warnings and Cautions

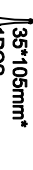
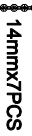
Turn off electricity at circuit breaker or main fuse box before installation. Consult a licensed electrician if in doubt. These instructions are provided for your safety. It is very important you read them completely before installing the fixture. We strongly recommend that a licensed, professional electrician perform the installation. Disconnect fixture from power source before replacing bulbs. Make sure bulbs are given sufficient time to cool before removal.

## Package Contents

-  **A** Fixture Body x1
-  14mm\*5PCS
-  35\*105mm\*1PCS
- 1** Crystals x12
-  14mm\*8PCS
-  35\*105mm\*1PCS
- 2** Crystals x8
-  14mm\*7PCS
-  35\*105mm\*1PCS
- 3** Crystals x4
-  14mm\*8PCS
-  35\*105mm\*1PCS
- 4** Crystals x1

## Hardware Contents

| PART | DESCRIPTION      | QUANTITY |
|------|------------------|----------|
| BB   | Wire nut         | 2pcs     |
| CC   | Outlet Box Screw | 2pcs     |

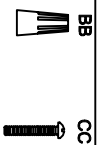

## STEP 1 - Release Crossbar from Ceiling Canopy

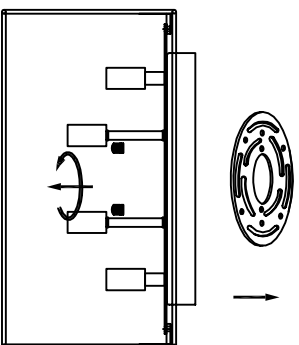

Figure 1

## STEP 2 - Attach Mounting bracket to Outlet Box

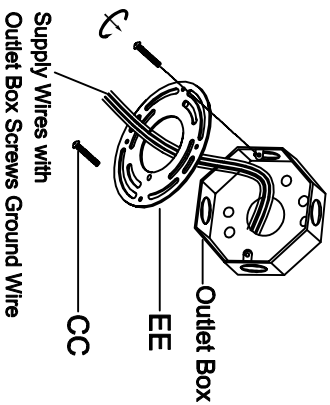

Figure 2

## STEP 4 - Install Bulbs.

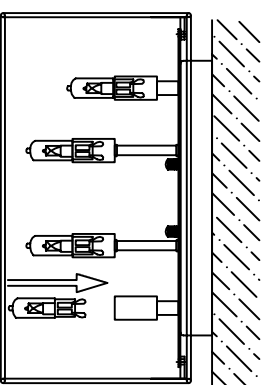

Figure 4

## STEP 3 - Wire Connections

A. Use standard wire connectors to make all wire connections. Twist connectors until wires are tightly joined together. Wrap each connection with approved electrical tape and carefully stuff all the connected wires into the Outlet Box.

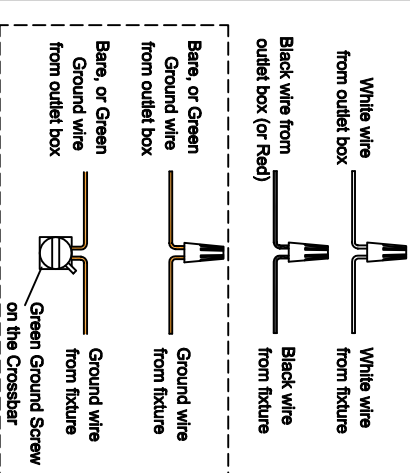

Figure 3

## STEP 5 - Install Crystal.

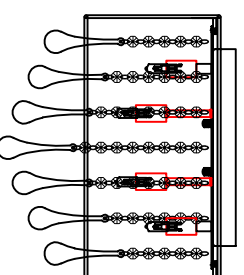

Figure 5