

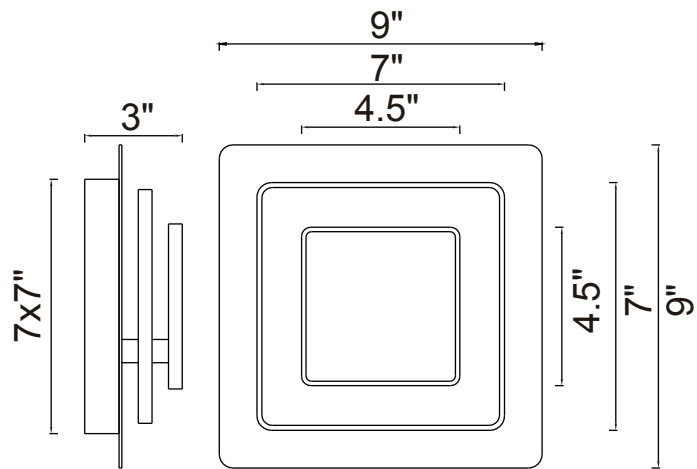

PROJECT: _____
 FIXTURE TYPE: _____
 LOCATION: _____
 CONTACT/PHONE: _____



Item	1238W9-103
Collection	Private I
Category	Wall Sconce
Finish	Matte White
Glass	-----
Crystal	-----
Acrylic	Frosted

Shade Color	-----
Min Assembled Height	9"
Max Assembled Height	9"
Width	9"
Length	-----
Extension Wall Mounts	3"
Input	120V AC,60HZ,AC

Lumens	468
Light Source	Integrated LED
Bulb Info.	9W
Included	Yes
Dimmable	Yes
Colour Temp	3000
Weight	2.2 Lbs

CWI Lighting
 2775 Broadway
 Buffalo, NY 14227
 USA

CWI Lighting
 140 Steelcase Rd. W.
 Markham ON. L3R 3J9
 Canada

Dallas Showroom
 Showroom #: 4707
 2100 N. Stemmons Frwy.
 Dallas, TX 75207

Email: info@cwilighting.com
 Toll: 1-877-564-6034
 www.cwilighting.com

